

# JETON®

www.jeton.com.tw

油霧回收真空曲管 · 萬向曲管

Vacuum Flex Tube  
Adjustable Coolant Hoses



JETON R/D & MFG. INC.  
宏明工業股份有限公司 / 宏啓工業股份有限公司  
No. 17, Lane 100, Tsao-Tyi Road, Ta-Li Dist., Taichung, Taiwan  
台灣台中市大里區草堤路100巷17號  
TEL: 886 - 4 - 24953456  
FAX: 886 - 4 - 24953399  
E-MAIL: jetoninc@seed.net.tw

上海奇晉貿易有限公司  
上海市寶山區三泉路1859弄63號1202室  
TEL: 021 - 65622765 , 021 - 65623571  
FAX: 021 - 65159705  
E-MAIL: jetoninc@163.com

# JETON®

www.jeton.com.tw

宏珩(宏啓)工業股份有限公司  
 是一家經營超過20年的專業塑膠射出廠，  
 專門生產工具機專用的高壓噴嘴、  
 油霧回收真空管、萬向曲管、噴霧裝置等，  
 並擁有堅強的研發團隊來滿足客戶的各種需求。  
 本公司秉持著採用高級的原料來生產商品，  
 以提供客戶最高品質的產品來達成顧客滿意度最大為原則，  
 且持續不斷的創新，  
 並根據市場的需求來研發新的商品，  
 讓客戶能有多樣化的選擇。

## CONTENTS

### 萬向曲管

萬向曲管系列介紹 .....	03
組合長度計算方法 .....	05
油霧回收真空管系列 .....	07
萬向曲管配件組配表 .....	09
系統規格 .....	21-24





# Adjustable Coolant Hoses

## 萬向曲管系列介紹

可任意調整長度、角度、變換口徑，專門用來輸送流體（液體、氣體）的曲管。可使用於金屬機械加工給水／給油、吹氣的曲管。

- ▶ 材料使用高品質的POM塑膠原料，具有抗化學性、油性、藥品性。
- ▶ 萬向曲管繞性佳，定位穩固，不會反彈。
- ▶ 彎曲後不會縮減內徑，也不會打結或疲乏。
- ▶ 與切削刀具碰撞，萬向曲管不會破壞切削刀具。
- ▶ 萬向曲管不會導電，適合用於EDM（放電加工機）。
- ▶ 有五種內徑尺寸：1/4", 3/8", 1/2", 3/4", 2 1/2"。
- ▶ 萬向曲管適用於低壓力的流體輸送。



### 曲管壓力與流量的特性

尺寸	建議操作壓力	流量
1/4" 系列	2.0~3.0 kg/cm <sup>2</sup>	900 公升/小時
3/8" 系列	2.0~3.0 kg/cm <sup>2</sup>	1500 公升/小時
1/2" 系列	1.4~2.0 kg/cm <sup>2</sup>	1700 公升/小時
3/4" 系列	0.7~1.4 kg/cm <sup>2</sup>	1900 公升/小時

### 建議使用

- ▶ 使用萬向曲管時，會因使用情況的不同，而影響曲管的最大壓力，建議任何時候做測試。

### 溫度說明

- ▶ 熔點：165° C
- ▶ 最高使用溫度：65° C

## 萬向曲管包裝

萬向曲管提供卡裝、袋裝、捲裝，可配合客戶實際的需求。



## 適用物品表

一般型萬向曲管以杜邦POM塑膠原料製造，色澤採用深藍色及橘色

品名	適用	不適用
乙醇	○	
丙酮	○	
清潔劑	○	
汽油	○	
潤滑油	○	
酒精	○	
礦物油	○	
氫氧化鈉	○	
農藥	○	
煞車油	○	
酸		×
強鹼		×
氨類過氧化物		×
次氯酸		×
次氯酸鈉		×

Omnipotent Adjustable Coolant Hose Packaging

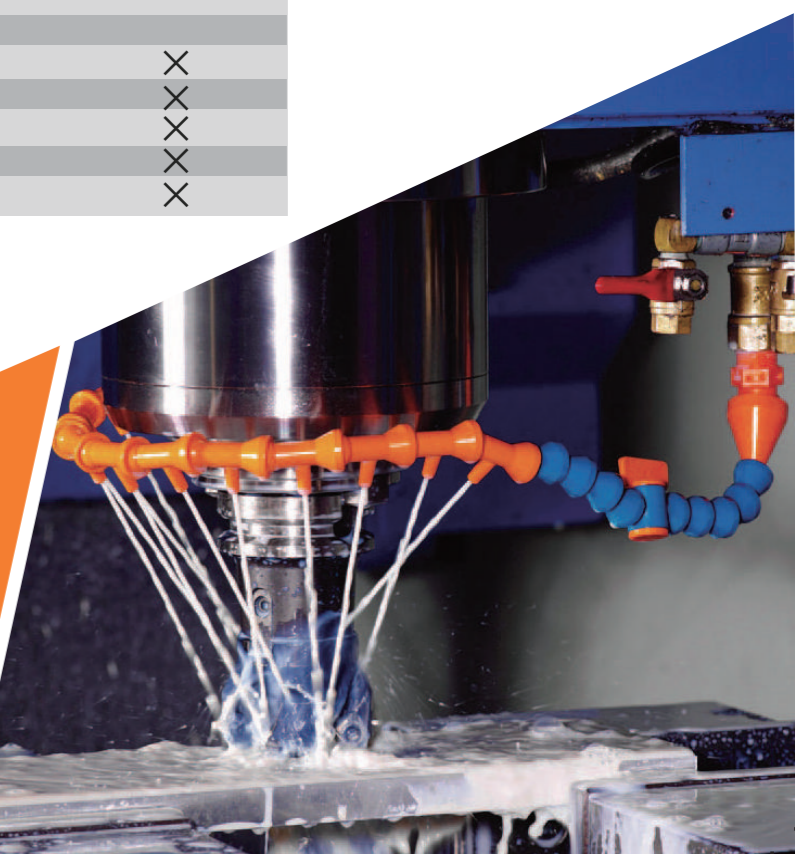

# Length Calculation Method

## 萬向曲管組合長度計算方法



接頭尺寸 (A) + 曲管本體尺寸 (B x 顆粒數) + 噴嘴尺寸 (C) = 全長

- ▶ **1/4"** 10.2 mm + 14.8 mm x 顆粒數 + 35.2 mm = 全長
- ▶ **3/8"** 12.7 mm + 17.3 mm x 顆粒數 + 39.2 mm = 全長
- ▶ **1/2"** 14.8 mm + 21.1 mm x 顆粒數 + 37.8 mm = 全長
- ▶ **3/4"** 14.2 mm + 23.7 mm x 顆粒數 + 43.0 mm = 全長

### 萬向曲管的組裝

使用專用的曲管組裝鉗即可簡單的拆裝曲管。

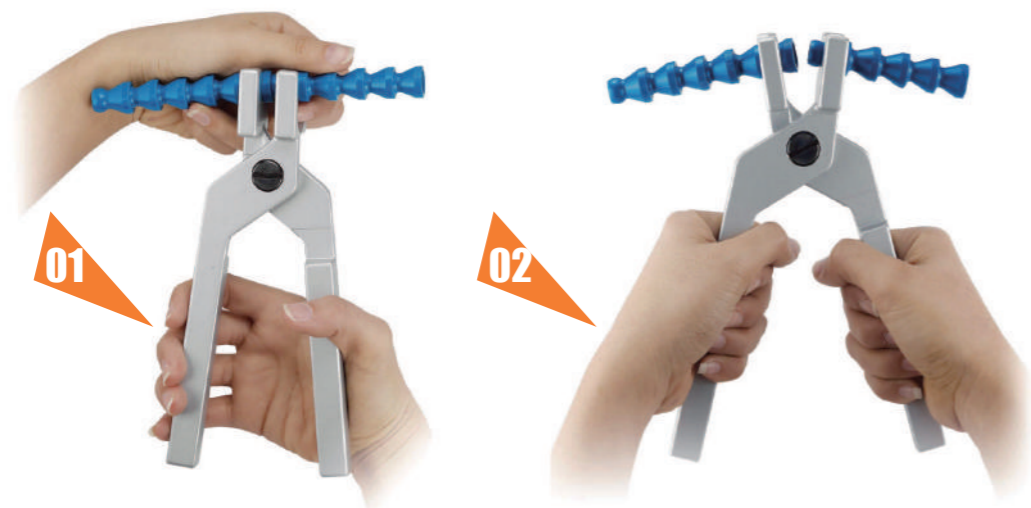

### 總流量控制組

能配合各種機械需求整合配置水流，在安裝上更為簡單容易，並能增加整台機械的美觀，操控水流更為方便。

#### JTM-01 控制組

- 總流量控制組座 1 組
- 1/4" 萬向曲管凡而組 1 支
- 3/8" 萬向曲管凡而組 3 支

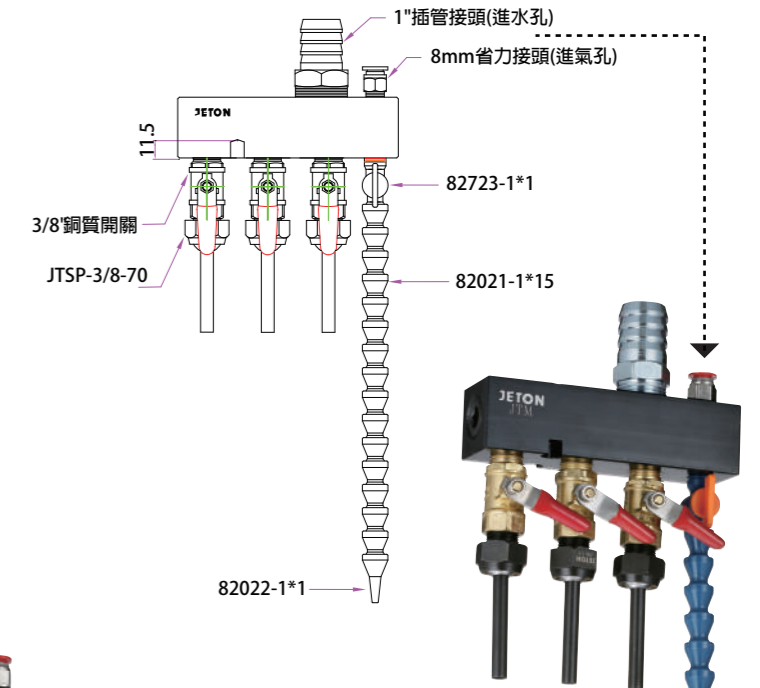
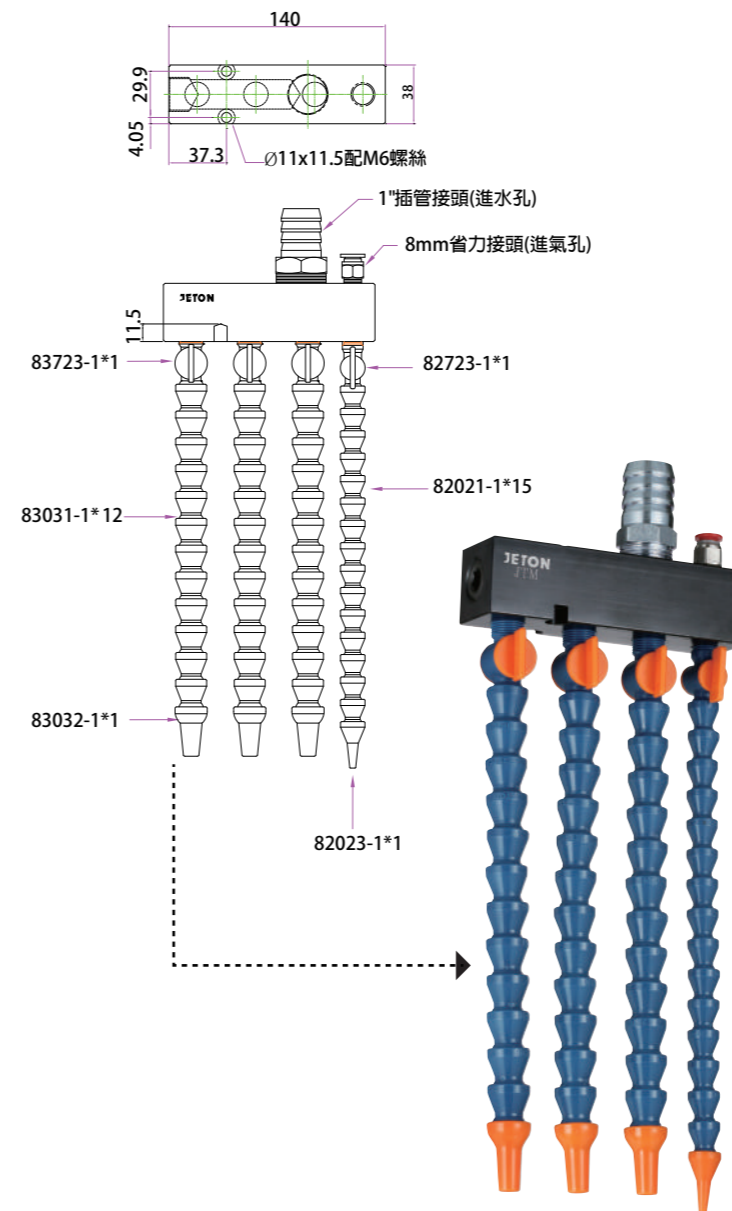

#### JTM-02 控制組

- 總流量控制組座 1 組
- 1/4" 萬向曲管凡而組 1 支
- 高壓式萬向噴嘴 3 顆
- 銅質開關 3 顆

## Total Flow Control Unit





產品	品號	產品規格
	89091 89191 89291	真空曲管組 9 個 / 組 18 個 / 組 180 個 / 組
	89094 89194	4.5" 圓形嘴 1 個 10 個
	89092 89192	6" x 3.5" 矩形嘴 1 個 10 個
	89093 89193	錐形嘴 1 個 10 個
	89722 89742	2.5" 滑動凡而 1 個 10 個
	89096 89196	真空曲管接頭，附掛耳 1 個 10 個
	89095 89195	真空曲管接頭 1 個 10 個

產品	品號	產品規格
	89098 89198	3" PVC 專用接頭 (連接美規PVC管專用) 1 個 10 個
	89097 89197	3" 金屬專用接頭 (連接金屬管專用) 1 個 10 個
	89099 89199	真空曲管接頭 1 個 10 個
	89021 89121	4" 轉 2.5" 真空曲管接頭 1 個 10 個
	89038	4" 轉 2.5" Y 形接頭 1 個
	89101	2.5" 固定座 1 個
	89102	4" 轉 2.5" 固定座 1 個
	89103	4" 轉 2.5" Y 形接頭固定座 1 個

## 油霧回收真空曲管特色

2 1/2"的油霧回收真空曲管是專門設計在油霧回收系統裡，用來吸取灰塵、煙霧和微粒。放在工作範圍之內方便調整角度。可隨著工作需求來更改長度。並有多樣的接頭與噴嘴，可提供選擇其中最適合的搭配。2 1/2"的油霧回收真空曲管可與美規3"PVC排水管或3"金屬管及可攜式吸塵器連接。

- ▶ 可旋轉360度，角度調整容易。可固定在理想的工作位置。
- ▶ 耐用和抗擠壓，不易被磨損。
- ▶ 用優質的杜邦塑膠材質製造，可抗大部份化學物品。
- ▶ 容易彎曲，彎曲後不會縮減內徑。彎曲半徑大約145mm。

### 溫度說明

- ▶ 熔點：165° C
- ▶ 最高使用溫度：65° C

### 警告

- ▶ 油霧回收真空曲管採用塑膠材質製造。這種原料是易燃的，須遠離火源，否則可能會引起火災。

### Vacuum Flex Tube

定位在加工處，可將加工時產生的濃煙、油煙，立即吸走。

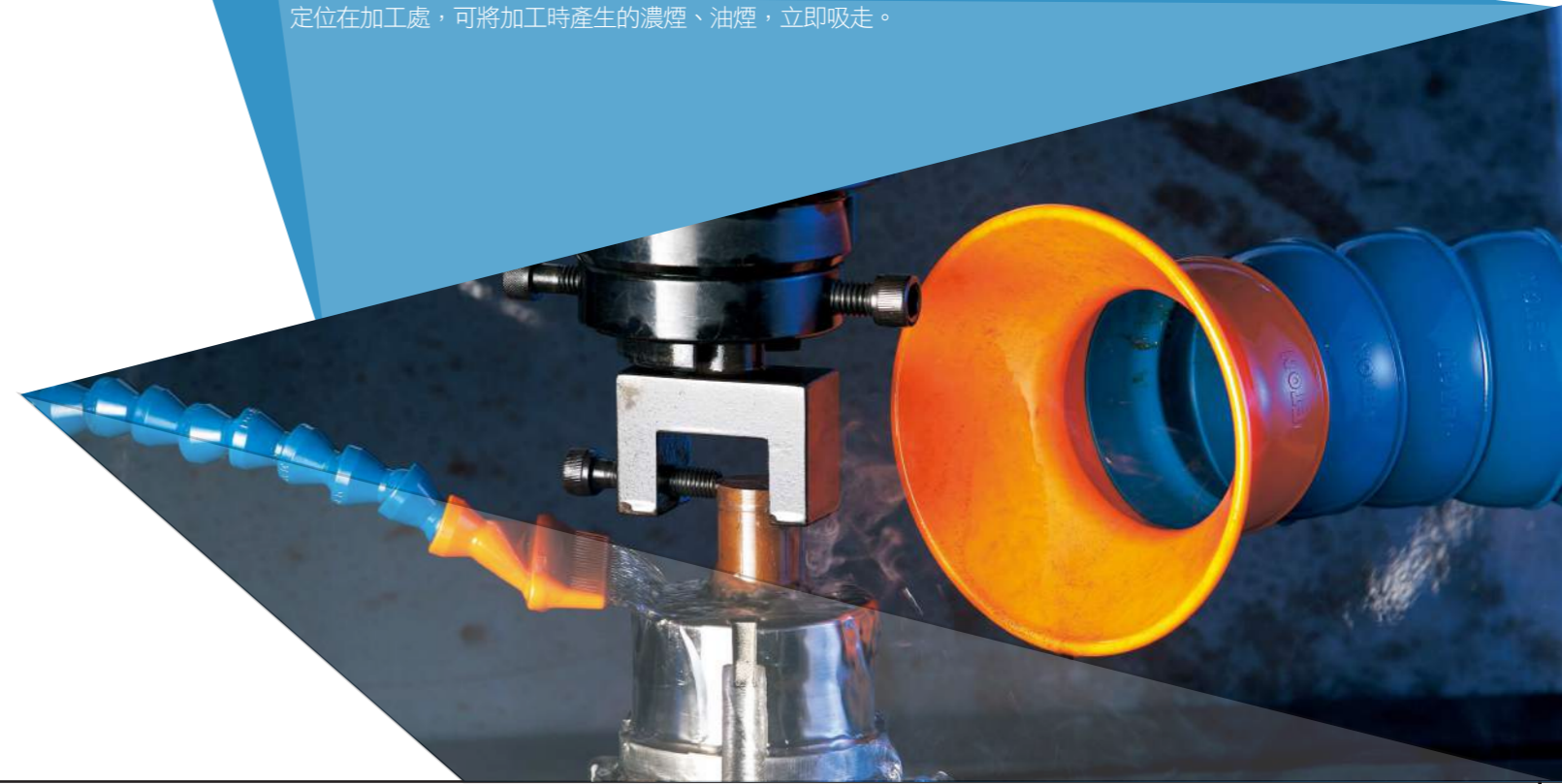

## 1/4" 系列

### ▶ 公母牙接頭

- 82025**  
1/8" PT 公牙接頭 
- 82026**  
1/4" PT 公牙接頭 
- 82013**  
5/8" UNF 母牙接頭 
- 82014**  
7/16" UNF 母牙接頭 
- 82723**  
1/4" 公牙凡而 
- 82724**  
1/4" 母牙凡而 

### ▶ 多形接頭

- 82028**  
1/4" Y型接頭 
- 82011**  
1/4" 雙向接頭 
- 82220**  
1/4" 加長型曲管組 
- 62420**  
1/4" L形接頭 
- 62422**  
1/4" 環狀噴嘴 
- 62424**  
1/4" 末端帽蓋 
- 62426**  
1/4" T形接頭 
- 82722**  
1/4" 連接凡而 
- 82725**  
1/4" 止逆閥 

### ▶ 接頭·噴嘴

- 82029**  
1/4" PT 公牙接頭 
- 82012**  
1/4" 管節, 1/8" NPT 母牙接頭 
- 82052**  
1/4" PT 母牙接頭 
- 82062**  
1/4" NPTF 母牙接頭 
- 82054**  
1/4" 直噴式噴嘴 
- 82055**  
1/4" 直噴式噴嘴 
- 82056**  
1/4" 直噴式多孔噴嘴 
- 82057**  
1/4" 直噴式多孔噴嘴 
- 82053**  
1/4" 直流式噴嘴 
- 82227**  
2-1/2" 扇形多孔噴嘴 
- 82022**  
1/16" 圓形噴嘴 
- 82023**  
1/8" 圓形噴嘴 
- 82024**  
1/4" 圓形噴嘴 
- 82223**  
1/16" 90° 噴嘴 
- 82224**  
1/8" 90° 噴嘴 
- 82225**  
1/4" 90° 噴嘴 
- 82226**  
1/4" 90° 多孔噴嘴 
- 82017**  
3/8" 扇形噴嘴 
- 82027**  
1" 扇形噴嘴 
- 82228**  
1/4" 扇形多孔噴嘴 
- 82229**  
1/4" 扇形多孔噴嘴 

## 1/2" 系列

### ▶ 公母牙接頭

- 84045**  
1/2" PT 公牙接頭 
- 84046**  
3/8" PT 公牙接頭 
- 84013**  
5/8" UNF 母牙 
- 84723**  
1/2" PT 公牙凡而 
- 84724**  
1/2" PT 母牙凡而 

### ▶ 多形接頭

- 84011**  
1/2" 雙向接頭 
- 84048**  
1/2" Y形接頭 
- 84049**  
1/2" 轉 1/4" Y形接頭 
- 84651**  
1/2" 轉 1/4" 接頭 
- 84440**  
1/2" 加長型曲管組 
- 64620**  
1/2" L形接頭 
- 64622**  
1/2" 環狀噴嘴 
- 64626**  
1/2" T形接頭 
- 84722**  
1/2" 連接凡而 
- 84725**  
1/2" 止逆閥 

### ▶ 噴嘴

- 84047**  
1-1/4" 扇形噴嘴 
- 84050**  
1-3/4" 扇形噴嘴 
- 84052**  
2-1/2" 扇形噴嘴 
- 84054**  
1/2" 直噴式噴嘴 
- 84055**  
1/2" 直噴式噴嘴 
- 84056**  
1/2" 直噴式多孔噴嘴 
- 84057**  
1/2" 直噴式多孔噴嘴 
- 84058**  
1-1/4" 直流式噴嘴 
- 84059**  
1-5/8" 直流式噴嘴 
- 84042**  
3/8" 圓形噴嘴 
- 84043**  
1/2" 圓形噴嘴 
- 84044**  
1/4" 圓形噴嘴 
- 84443**  
1/4" 90° 噴嘴 
- 84444**  
3/8" 90° 噴嘴 
- 84445**  
1/2" 90° 噴嘴 
- 84446**  
1/2" 90° 多孔噴嘴 
- 84447**  
2-1/2" 扇形多孔噴嘴 

## 3/8" 系列

### ▶ 公母牙接頭

- 83035**  
3/8" PT 公牙接頭 
- 83036**  
1/2" PT 公牙接頭 
- 83026**  
1/4" PT 公牙轉 3/8" 曲管接頭 
- 83723**  
3/8" PT 公牙凡而 
- 83724**  
3/8" PT 母牙凡而 

### ▶ 多形接頭

- 83038**  
3/8" Y形接頭 
- 83011**  
3/8" 雙向接頭 
- 83651**  
3/8" 轉 1/4" 接頭 
- 83722**  
3/8" 連接凡而 
- 83725**  
3/8" 止逆閥 

### ▶ 噴嘴

- 83032**  
1/4" 圓形噴嘴 
- 83033**  
3/8" 圓形噴嘴 
- 83034**  
1/2" 圓形噴嘴 
- 83037**  
1-1/4" 扇形噴嘴 

### ▶ 公母牙接頭

- 86064**  
3/4" PT 公牙接頭 
- 86723**  
3/4" PT 公牙凡而 
- 86724**  
3/4" PT 母牙凡而 

### ▶ 多形接頭

- 86068**  
3/4" Y形接頭 
- 86069**  
3/4" 轉 1/2" Y形接頭 
- 86051**  
3/4" 轉 1/2" 接頭 
- 86011**  
3/4" 雙向接頭 
- 66620**  
3/4" L形接頭 
- 86722**  
3/4" 連接凡而 



### ▶ 噴嘴

- 86063**  
5/8" 圓形噴嘴 
- 86062**  
3/4" 圓形噴嘴 
- 86067**  
3" 扇形噴嘴 

產品	品號	產品規格	產品	品號	產品規格	產品	品號	產品規格	產品	品號	產品規格	產品	品號	產品規格			
	<b>82020</b>	1/4" 曲管組 15 cm 曲管 2 條 1/16", 1/8", 1/4" 圓形噴嘴各 1 個 1/8" & 1/4" PT 公牙接頭各 1 個		<b>82326</b>	1/4" 90° 噴嘴組 1/16", 1/8", 1/4" 90° 圓形噴嘴與 1/4" 90° 多孔噴嘴 各 1 個		<b>82054</b> <b>82074</b>	1/4" 直噴式噴嘴 (1mm) 2 個 20 個		<b>82028</b> <b>82038</b>	1/4" Y 形接頭 2 個 20 個		<b>62422</b> <b>62442</b>	1/4" 環狀噴嘴 4 個 20 個		<b>82723A</b> <b>82733A</b>	1/4" NPT 公牙凡而 2 個 10 個
	<b>82020A</b>	1/4" 曲管組 15 cm 曲管 2 條 1/16", 1/8", 1/4" 圓形噴嘴各 1 個 1/8" & 1/4" NPT 公牙接頭各 1 個		<b>82022</b> <b>82042</b>	1/16" 圓形噴嘴 4 個 50 個		<b>82055</b> <b>82075</b>	1/4" 直噴式噴嘴 (1.5mm) 2 個 20 個		<b>82011</b> <b>82031</b>	1/4" 雙向接頭 4 個 20 個		<b>62424</b> <b>62444</b>	1/4" 末端帽蓋 4 個 20 個		<b>82724</b> <b>82744</b>	1/4" PT 母牙凡而 2 個 10 個
	<b>82220</b>	1/4" 加長型曲管組 加長型曲管 4 個 管束 4 個		<b>82023</b> <b>82043</b>	1/8" 圓形噴嘴 4 個 50 個		<b>82057</b> <b>82077</b>	1/4" 直噴式多孔噴嘴 (5*1.5mm) 2 個 20 個		<b>82012</b> <b>82032</b>	1/4" 管節， 1/8" NPT 母牙接頭 4 個 20 個		<b>82227</b> <b>82247</b>	2 1/2" 扇形多孔噴嘴 (孔直徑 1.8) 2 個 20 個		<b>82724A</b> <b>82744A</b>	1/4" NPT 母牙凡而 2 個 10 個
	<b>82021</b>	1/4" 曲管 15 cm 2 條		<b>82024</b> <b>82044</b>	1/4" 圓形噴嘴 4 個 50 個		<b>82057</b> <b>82077</b>	1/4" 直噴式多孔噴嘴 (5*1.5mm) 2 個 20 個		<b>82052</b> <b>82072</b>	1/4" PT 母牙接頭 4 個 50 個		<b>82228</b> <b>82248</b>	1/4" 扇形多孔噴嘴 (孔直徑 1.0) 2 個 20 個		<b>82725</b> <b>82745</b>	1/4" 止逆閥 2 個 10 個
	<b>82051</b> <b>82071</b>	1/4" 曲管 1524 cm 1 捲 2500 cm 1 捲		<b>82223</b> <b>82243</b>	1/16" 90° 噴嘴 4 個 20 個		<b>82053</b> <b>82073</b>	1" 直噴式噴嘴 2 個 20 個		<b>82052F</b> <b>82072F</b>	1/4" PF 母牙接頭 4 個 50 個		<b>82229</b> <b>82249</b>	1/4" 扇形多孔噴嘴 (孔直徑 1.5) 2 個 20 個		<b>52400</b>	1/4" 歧管組 1/4" 歧管固定架 1 個 1/4" T 形接頭 3 個 1/4" L 形接頭 1 個 固定螺絲 3 個
	<b>82051</b> <b>82071</b>	1/4" 曲管 1524 cm 1 捲 2500 cm 1 捲		<b>82224</b> <b>82244</b>	1/8" 90° 噴嘴 4 個 20 個		<b>82025</b> <b>82035</b>	1/8" NPT 公牙接頭 4 個 50 個		<b>82062</b> <b>82082</b>	1/4" NPT 母牙接頭 4 個 50 個		<b>82721A</b> <b>82731A</b>	1/4" NPT 公牙插管凡而 2 個 10 個		<b>52410</b>	1/4" 主道控制歧管組 1/4" 歧管組 1 組 1/4" 連接凡而 5 個
	<b>62423</b>	1/4" 環狀噴嘴組 環狀噴嘴 15 個 末端帽蓋 1 個		<b>82225</b> <b>82245</b>	1/4" 90° 噴嘴 4 個 20 個		<b>82025A</b> <b>82035A</b>	1/8" NPT 公牙接頭 4 個 50 個		<b>82013</b> <b>82033</b>	5/8" UNF 母牙接頭 4 個 20 個		<b>82722</b> <b>82732</b>	1/4" 連接凡而 2 個 10 個		<b>52410</b>	1/4" 主道控制歧管組 1/4" 歧管組 1 組 1/4" 連接凡而 5 個
	<b>82221</b> <b>82241</b>	1/4" 加長型曲管 4 個 20 個		<b>82226</b> <b>82246</b>	1/4" 90° 多孔噴嘴 2 個 20 個		<b>82026</b> <b>82036</b>	1/4" PT 公牙接頭 4 個 50 個		<b>82014</b> <b>82034</b>	7/16" UNF 母牙接頭 4 個 20 個		<b>82723</b> <b>82733</b>	1/4" PT 公牙凡而 2 個 10 個		<b>52416</b>	1/4" 歧管固定架 2 個
	<b>82222</b> <b>82242</b>	1/4" 管束 4 個 20 個		<b>82017</b> <b>82037</b>	3/8" 扇形噴嘴 2 個 20 個		<b>82026A</b> <b>82036A</b>	1/4" NPT 公牙接頭 4 個 50 個		<b>62420</b> <b>62430</b>	1/4" L 形接頭 2 個 20 個		<b>82723</b> <b>82733</b>	1/4" PT 公牙凡而 2 個 10 個		<b>26171</b>	1/4" 曲管組裝鉗 1 支
	<b>82222</b> <b>82242</b>	1/4" 管束 4 個 20 個		<b>82027</b> <b>82047</b>	1" 扇形噴嘴 2 個 20 個		<b>82029</b> <b>82039</b>	1/4" PT 公牙接頭 4 個 50 個		<b>62426</b> <b>62436</b>	1/4" T 形接頭 2 個 20 個						



產品	品號	產品規格
	<b>83030</b>	3/8" 曲管組 14.5 cm 曲管 2 條
		3/8" 圓形噴嘴 1 個
		3/8" PT 公牙接頭 1 個



產品	品號	產品規格
	<b>83030A</b>	3/8" 曲管組 14.5 cm 曲管 2 條
		3/8" 圓形噴嘴 1 個
		3/8" NPT 公牙接頭 1 個

產品	品號	產品規格
	<b>83430</b>	3/8" 曲管組 14.5 cm 曲管 2 條
		1/4", 3/8", 1/2" 圓形噴嘴各 1 個
		3/8" 和 1/2" PT 公牙接頭各 1 個

產品	品號	產品規格
	<b>83430A</b>	3/8" 曲管組 14.5 cm 曲管 2 條
		1/4", 3/8", 1/2" 圓形噴嘴各 1 個
		3/8" 和 1/2" NPT 公牙接頭各 1 個



產品	品號	產品規格
	<b>83031</b>	3/8" 曲管組 14.5 cm 2 條



產品	品號	產品規格
	<b>83051</b>	3/8" 曲管組 762 cm 1 捲
	<b>83091</b>	3/8" 曲管組 1524 cm 1 捲



產品	品號	產品規格
	<b>83032</b>	1/4" 圓形噴嘴 4 個
	<b>83052</b>	3/8" 圓形噴嘴 50 個



產品	品號	產品規格
	<b>83033</b>	3/8" 圓形噴嘴 4 個
	<b>83053</b>	3/8" 圓形噴嘴 50 個



產品	品號	產品規格
	<b>83034</b>	1/2" 圓形噴嘴 4 個
	<b>83054</b>	1/2" 圓形噴嘴 50 個



產品	品號	產品規格
	<b>83026</b>	1/4" PT 公牙接頭 4 個
	<b>83046</b>	1/4" PT 公牙接頭 50 個

產品	品號	產品規格
	<b>83035</b>	3/8" PT 公牙接頭 4 個
	<b>83055</b>	3/8" PT 公牙接頭 50 個



產品	品號	產品規格
	<b>83035A</b>	3/8" NPT 公牙接頭 4 個
	<b>83055A</b>	3/8" NPT 公牙接頭 50 個



產品	品號	產品規格
	<b>83036</b>	1/2" PT 公牙接頭 4 個
	<b>83056</b>	1/2" PT 公牙接頭 50 個



產品	品號	產品規格
	<b>83036A</b>	1/2" NPT 公牙接頭 4 個
	<b>83056A</b>	1/2" NPT 公牙接頭 50 個



產品	品號	產品規格
	<b>83037</b>	1 1/4" 扇形噴嘴 2 個
	<b>83057</b>	1 1/4" 扇形噴嘴 20 個



產品	品號	產品規格
	<b>83038</b>	3/8" Y形接頭 2 個
	<b>83058</b>	3/8" Y形接頭 20 個



產品	品號	產品規格
	<b>83011</b>	3/8" 雙向接頭 4 個
	<b>83041</b>	3/8" 雙向接頭 20 個

產品	品號	產品規格
	<b>83725</b>	3/8" 止逆閥 2 個
	<b>83745</b>	3/8" 止逆閥 10 個



產品	品號	產品規格
	<b>83651</b>	3/8" 轉 1/4" 接頭 2 個
	<b>83851</b>	3/8" 轉 1/4" 接頭 20 個

產品	品號	產品規格
	<b>83722</b>	3/8" 連接凡而 2 個
	<b>83742</b>	3/8" 連接凡而 10 個

產品	品號	產品規格
	<b>83723</b>	3/8" PT 公牙凡而 2 個
	<b>83743</b>	3/8" PT 公牙凡而 10 個

產品	品號	產品規格
	<b>83723A</b>	3/8" NPT 公牙凡而 2 個
	<b>83743A</b>	3/8" NPT 公牙凡而 10 個

產品	品號	產品規格
	<b>83724</b>	3/8" PT 母牙凡而 2 個
	<b>83744</b>	3/8" PT 母牙凡而 10 個

產品	品號	產品規格
	<b>83724A</b>	3/8" NPT 母牙凡而 2 個
	<b>83744A</b>	3/8" NPT 母牙凡而 10 個

產品	品號	產品規格
	<b>26176</b>	3/8" 曲管組裝鉗 1 支

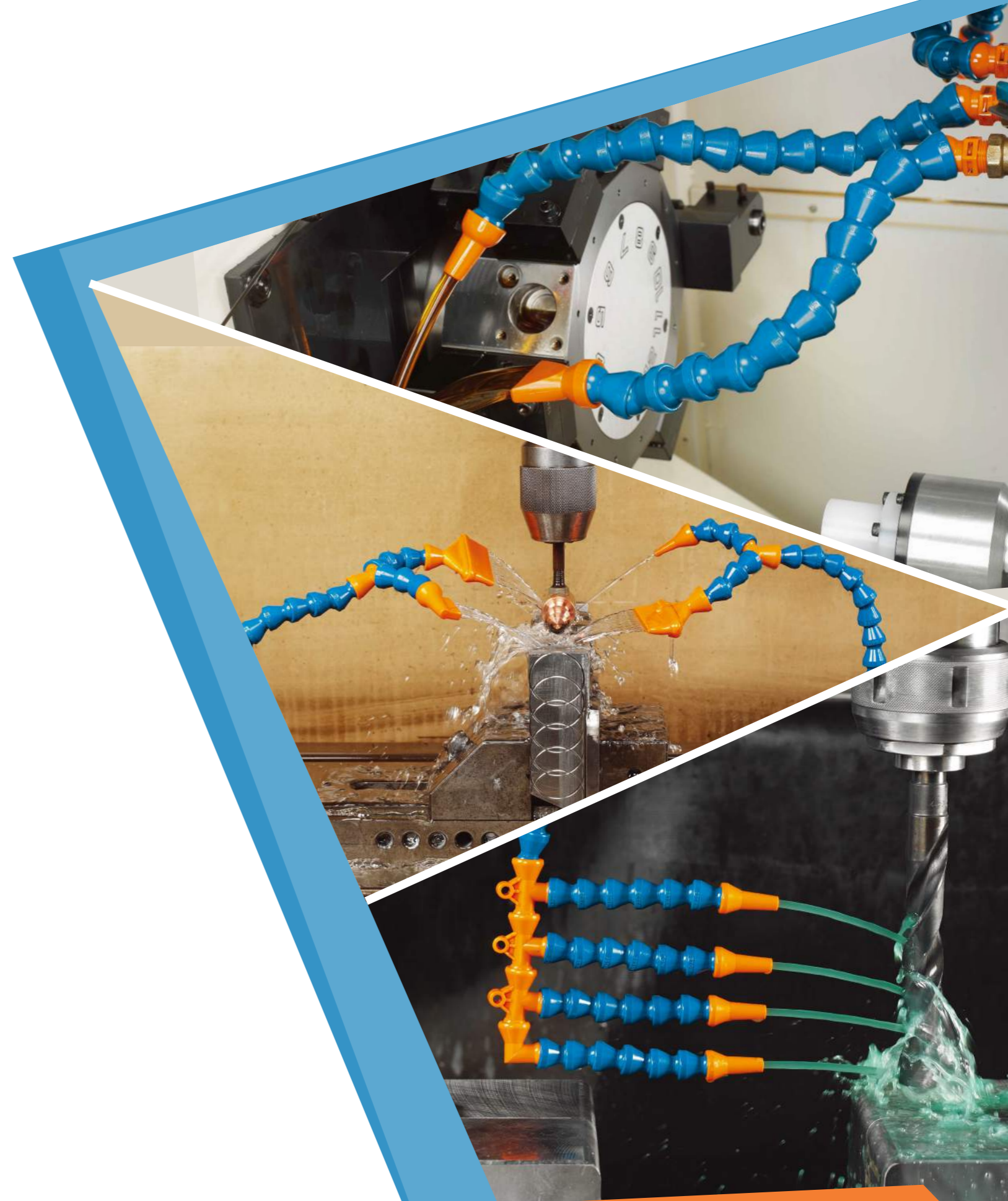











產品	品號	產品規格	產品	品號	產品規格	產品	品號	產品規格	產品	品號	產品規格	產品	品號	產品規格
	<b>84040</b>	1/2" 曲管組 13.5 cm 曲管 2 條 1/4", 3/8", 1/2" 圓形噴嘴各 1 個 3/8" 和 1/2" PT 公牙接頭各 1 個		<b>84346</b>	1/2 90° 噴嘴組 1/4", 3/8", 1/2" 90° 圓形噴嘴與 1/2" 90° 多孔噴嘴 各 1 個		<b>84054</b> <b>84074</b>	1/2" 直噴式噴嘴 (2mm) 2 個 20 個		<b>84447</b> <b>84467</b>	2 1/2" 扇形多孔噴嘴 (孔直徑 2) 2 個 20 個		<b>64620</b> <b>64640</b>	1/2" L 形接頭 2 個 20 個
	<b>84040A</b>	1/2" 曲管組 13.5 cm 曲管 2 條 1/4", 3/8", 1/2" 圓形噴嘴各 1 個 3/8" 和 1/2" NPT 公牙接頭各 1 個		<b>84044</b> <b>84064</b>	1/4" 圓形噴嘴 4 個 50 個		<b>84055</b> <b>84075</b>	1/2" 直噴式噴嘴 (3.2mm) 2 個 20 個		<b>84046</b> <b>84066</b>	3/8" PT 公牙接頭 4 個 50 個		<b>64626</b> <b>64646</b>	1/2" T 形接頭 2 個 20 個
	<b>84440</b>	1/2" 加長型曲管組 加長型曲管 4 個 管束 4 個		<b>84042</b> <b>84062</b>	3/8" 圓形噴嘴 4 個 50 個		<b>84056</b> <b>84076</b>	1/2" 直噴式多孔噴嘴 (7*2mm) 2 個 20 個		<b>84046A</b> <b>84066A</b>	3/8" NPT 公牙接頭 4 個 50 個		<b>64622</b> <b>64642</b>	1/2" 環狀噴嘴 4 個 20 個
	<b>84041</b>	1/2" 曲管 13.5 cm 2 條		<b>84043</b> <b>84063</b>	1/2" 圓形噴嘴 4 個 50 個		<b>84057</b> <b>84077</b>	1/2" 直噴式多孔噴嘴 (5*3.2mm) 2 個 20 個		<b>84045</b> <b>84065</b>	1/2" PT 公牙接頭 4 個 50 個		<b>64624</b> <b>64644</b>	1/2" 末端帽蓋 4 個 20 個
	<b>84081</b> <b>84091</b>	1/2" 曲管 1524 cm 1 捲 2500 cm 1 捲		<b>84043</b> <b>84063</b>	1/4" 圓形噴嘴 4 個 50 個		<b>84058</b> <b>84078</b>	1 1/4" 直噴式噴嘴 2 個 20 個		<b>84045A</b> <b>84065A</b>	1/2" NPT 公牙接頭 4 個 50 個		<b>84722</b> <b>84742</b>	1/2" 連接凡而 2 個 10 個
	<b>84081</b> <b>84091</b>	1/2" 曲管 1524 cm 1 捲 2500 cm 1 捲		<b>84443</b> <b>84463</b>	1/4" 90° 噴嘴 4 個 20 個		<b>84059</b> <b>84079</b>	1 5/8" 直噴式噴嘴 2 個 20 個		<b>84048</b> <b>84068</b>	1/2" Y 形接頭 2 個 20 個		<b>84723</b> <b>84743</b>	1/2" PT 公牙凡而 2 個 10 個
	<b>64643</b>	1/2" 環狀噴嘴組 環狀噴嘴 15 個 末端帽蓋 1 個		<b>84444</b> <b>84464</b>	3/8" 90° 噴嘴 4 個 20 個		<b>84047</b> <b>84067</b>	1 1/4" 扇形噴嘴 2 個 20 個		<b>84049</b> <b>84069</b>	1/2" 轉 1/4" Y 形接頭 2 個 20 個		<b>84723A</b> <b>84743A</b>	1/2" NPT 公牙凡而 2 個 10 個
	<b>84441</b> <b>84461</b>	1/2" 加長型曲管 4 個 20 個		<b>84445</b> <b>84465</b>	1/2" 90° 噴嘴 4 個 20 個		<b>84050</b> <b>84070</b>	1 3/4" 扇形噴嘴 2 個 20 個		<b>84651</b> <b>84851</b>	1/2" 轉 1/4" 接頭 2 個 20 個		<b>84724</b> <b>84744</b>	1/2" PT 母牙凡而 2 個 10 個
	<b>84442</b> <b>84462</b>	1/2" 管束 4 個 20 個		<b>84446</b> <b>84466</b>	1/2" 90° 多孔噴嘴 2 個 20 個		<b>84052</b> <b>84072</b>	2 1/2" 扇形噴嘴 2 個 20 個		<b>84011</b> <b>84031</b>	1/2" 雙向接頭 4 個 20 個		<b>84724A</b> <b>84744A</b>	1/2" NPT 母牙凡而 2 個 10 個
													<b>84725</b> <b>84745</b>	1/2" 止逆閥 2 個 10 個
													<b>84013</b> <b>84033</b>	5/8" UNF 母牙 4 個 20 個
													<b>54400</b>	1/2" 歧管組 1/2" 歧管固定架 1 個 1/2" T 形接頭 3 個 1/2" L 形接頭 1 個 固定螺絲 3 個
													<b>54410</b>	1/2" 主道控制歧管組 1/2" 歧管組 1 組 1/2" 連接凡而 5 個
													<b>54416</b>	1/2" 歧管固定架 2 個
													<b>26172</b>	1/2" 曲管組裝鉗 1 支

## 3/4" 系列 (3/4" 內徑)

產品	品號	產品規格	產品	品號	產品規格	產品	品號	產品規格
	<b>86060</b>	3/4" 曲管組 15 cm 曲管 2 條 5/8" 與 3/4" 圓嘴 各 1 個 3/4" PT 公牙接頭 1 個		<b>86064A</b> <b>86074A</b>	3/4" NPT 公牙接頭 4 個 50 個		<b>86011</b> <b>86031</b>	3/4" 雙向接頭 4 個 20 個
	<b>86060A</b>	3/4" 曲管組 15 cm 曲管 2 條 5/8" 與 3/4" 圓嘴 各 1 個 3/4" NPT 公牙接頭 1 個		<b>86021</b>	3/4" 固定接頭 2 個		<b>66620</b> <b>66640</b>	3/4" L 形接頭 2 個 20 個
	<b>86061</b>	3/4" 曲管組 15 cm 2 條		<b>86022</b>	3/4" 磁座 1 個		<b>86722</b> <b>86742</b>	3/4" 連接凡而 2 個 10 個
	<b>86081</b> <b>86091</b>	3/4" 曲管組 1524 cm 1 捲 2500 cm 1 捲		<b>86023</b>	擋板連接接頭 2 個		<b>86723</b> <b>86743</b>	3/4" PT 公牙凡而 2 個 10 個
	<b>86063</b> <b>86073</b>	5/8" 圓形噴嘴 4 個 50 個		<b>86067</b> <b>86077</b>	3" 扇形噴嘴 2 個 20 個		<b>86723A</b> <b>86743A</b>	3/4" NPT 公牙凡而 2 個 10 個
	<b>86062</b> <b>86072</b>	3/4" 圓形噴嘴 4 個 50 個		<b>86068</b> <b>86078</b>	3/4" Y 形接頭 2 個 20 個		<b>86724</b> <b>86744</b>	3/4" PT 母牙凡而 2 個 10 個
	<b>86064</b> <b>86074</b>	3/4" PT 公牙接頭 4 個 50 個		<b>86069</b> <b>86079</b>	3/4" 轉 1/2" Y 形接頭 2 個 20 個		<b>86724A</b> <b>86744A</b>	3/4" NPT 母牙凡而 2 個 10 個
				<b>86051</b> <b>86071</b>	3/4" 轉 1/2" 接頭 2 個 20 個		<b>26177</b>	3/4" 曲管組裝鉗 1 支

## 萬向曲管凡而組

	<b>62720</b> 36cm 曲管組	1/4" PT 或 NPT 公牙凡而 20 顆 1/4" 曲管 1/16" 或 1/8" 或 1/4" 圓嘴	1 顆 1 條 1 顆	<b>1/4"</b>		<b>62721</b> 36cm 曲管組	1/4" PT 或 NPT 母牙凡而 20 顆 1/4" 曲管 1/16" 或 1/8" 或 1/4" 圓嘴	1 顆 1 條 1 顆
	<b>63720</b> 36cm 曲管組	3/8" PT 或 NPT 公牙凡而 16 顆 3/8" 曲管 1/4" 或 3/8" 或 1/2" 圓嘴	1 顆 1 條 1 顆	<b>3/8"</b>		<b>63721</b> 36cm 曲管組	3/8" PT 或 NPT 母牙凡而 16 顆 3/8" 曲管 1/4" 或 3/8" 或 1/2" 圓嘴	1 顆 1 條 1 顆
	<b>64720</b> 35cm 曲管組	1/2" PT 或 NPT 公牙凡而 12 顆 1/2" 曲管 1/4" 或 3/8" 或 1/2" 圓嘴	1 顆 1 條 1 顆	<b>1/2"</b>		<b>64721</b> 35cm 曲管組	1/2" PT 或 NPT 母牙凡而 12 顆 1/2" 曲管 1/4" 或 3/8" 或 1/2" 圓嘴	1 顆 1 條 1 顆
	<b>66720</b> 40cm 曲管組	3/4" PT 或 NPT 公牙凡而 12 顆 3/4" 曲管 5/8" 或 3/4" 圓嘴	1 顆 1 條 1 顆	<b>3/4"</b>		<b>66721</b> 40cm 曲管組	3/4" PT 或 NPT 母牙凡而 12 顆 3/4" 曲管 5/8" 或 3/4" 圓嘴	1 顆 1 條 1 顆



## 1/4"

品號	產品規格	
<b>1/4" 抗酸曲管</b>		
52021	14 cm	2 條
52051	1524 cm	1 捲
52071	2500 cm	1 捲
<b>1/16" 抗酸圓形噴嘴</b>		
52022		4 個
52042		50 個
<b>1/8" 抗酸圓形噴嘴</b>		
52023		4 個
52043		50 個
<b>1/4" 抗酸圓形噴嘴</b>		
52024		4 個
52044		50 個
<b>3/8" 抗酸扇形噴嘴</b>		
52017		2 個
52037		20 個
<b>1" 抗酸扇形噴嘴</b>		
52027		2 個
52047		20 個
<b>1/8" PT 抗酸接頭</b>		
52025		4 個
52035		50 個
<b>1/8" NPT 抗酸接頭</b>		
52025A		4 個
52035A		50 個
<b>1/4" PT 抗酸接頭</b>		
52026		4 個
52036		50 個
<b>1/4" NPT 抗酸接頭</b>		
52026A		4 個
52036A		50 個
<b>1/4" PT 抗酸接頭</b>		
52029		4 個
52039		50 個
<b>1/4" 抗酸 Y 形接頭</b>		
52028		4 個
52038		50 個
<b>1/4" 抗酸雙向接頭</b>		
52011		4 個
52031		20 個
<b>1/4" 抗酸 L 形接頭</b>		
52420		2 個
52430		20 個
<b>1/4" 抗酸 T 形接頭</b>		
52426		2 個
52436		20 個

## 3/8"

品號	產品規格	
<b>3/8" 抗酸曲管</b>		
53031	14.5 cm	2 條
53051	762 cm	1 捲
53091	1524 cm	1 捲
<b>1/4" 抗酸圓形噴嘴</b>		
53032		4 個
53052		50 個
<b>3/8" 抗酸圓形噴嘴</b>		
53033		4 個
53053		50 個
<b>1/2" 抗酸圓形噴嘴</b>		
53034		4 個
53054		50 個
<b>1/4" PT 轉 3/8"</b>		
53026		4 個
53046		50 個
<b>3/8" PT 抗酸接頭</b>		
53035		4 個
53055		50 個
<b>3/8" NPT 抗酸接頭</b>		
53035A		4 個
53055A		50 個
<b>1/2" PT 抗酸接頭</b>		
53036		4 個
53056		50 個
<b>1/2" NPT 抗酸接頭</b>		
53036A		4 個
53056A		50 個
<b>1-1/4" 抗酸扇形噴嘴</b>		
53037		2 個
53057		20 個

## 1/2"

品號	產品規格	
<b>1/2" 抗酸曲管</b>		
54041	14 cm	2 條
54081	1524 cm	1 捲
53091	2500 cm	1 捲
<b>1/4" 抗酸圓形噴嘴</b>		
54044		4 個
54064		50 個
<b>3/8" 抗酸圓形噴嘴</b>		
54042		4 個
54062		50 個
<b>1/2" 抗酸圓形噴嘴</b>		
54043		4 個
54063		50 個
<b>1-1/4" 抗酸扇形噴嘴</b>		
54047		2 個
54067		20 個
<b>1-3/4" 抗酸扇形噴嘴</b>		
54050		2 個
54070		20 個
<b>2-1/2" 抗酸扇形噴嘴</b>		
54052		2 個
54072		20 個
<b>3/8" PT 抗酸接頭</b>		
54046		4 個
54066		50 個
<b>3/8" NPT 抗酸接頭</b>		
54046A		4 個
54066A		50 個
<b>1/2" PT 抗酸接頭</b>		
54045		4 個
54065		50 個
<b>1/2" NPT 抗酸接頭</b>		
54045A		4 個
54065A		50 個
<b>1/2" 抗酸 Y 形接頭</b>		
54048		2 個
54068		20 個
<b>1/2" 轉 1/4" 抗酸 Y 形接頭</b>		
54049		2 個
54069		20 個
<b>1/2" 轉 1/4" 抗酸接頭</b>		
54651		2 個
54851		20 個
<b>1/2" 抗酸雙向接頭</b>		
54011		4 個
54031		20 個
<b>1/2" 抗酸 L 形接頭</b>		
54620		2 個
54640		20 個
<b>1/2" 抗酸 T 形接頭</b>		
54626		2 個
54646		20 個



## 擋板系列

**34101** (6" x 8") 擋板組

**34102** (7-1/2" x 10")

**34103** (8-1/2" x 12")

磁座底部	1 組
3/4" 固定接頭	1 顆
12 顆 3/4" 曲管	1 條
3/4" L 形公牙接頭	1 顆
螺帽	2 顆
壓克力板	1 片

### 適用物品表

抗酸萬向曲管以聚酯塑膠製造，色澤採用灰色

品名	適用	不適用
乙醇	○	
酸 (加熱65°C 以下)	○	
汽油	○	
潤滑油	○	
碳氫化合物	○	
礦物油	○	
食鹽溶劑	○	
水 (加熱65°C 以上)		X
酸 (加熱65°C 以上)		X
丙酮		X
甲苯		X
氯化溶劑		X
醋酸乙酯		X
強鹼		X

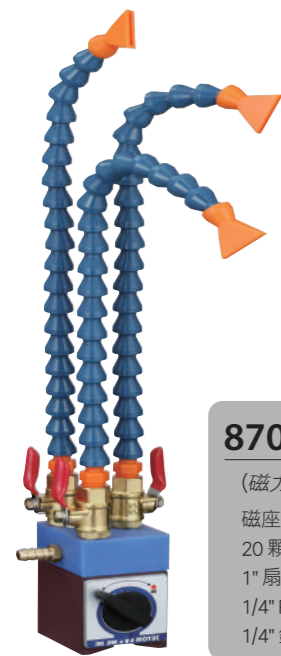

### 87011 磁座組

(磁力On-Off)

- 磁座底部 (W5 X L 6.5 X H 5cm) 1 組
- 20 顆 1/4" 曲管 3 條
- 1" 扇形噴嘴 3 顆
- 1/4" PT 接頭 3 顆
- 1/4" 銅質開關 3 顆



### 87002 磁座組

(磁力On-Off)

- 磁座底部 (W5 X L 6.5 X H 5cm) 1 組
- 20 顆 1/4" 曲管 2 條
- 1" 扇形噴嘴 2 顆
- 1/4" PT 接頭 2 顆
- 1/4" 銅質開關 2 顆

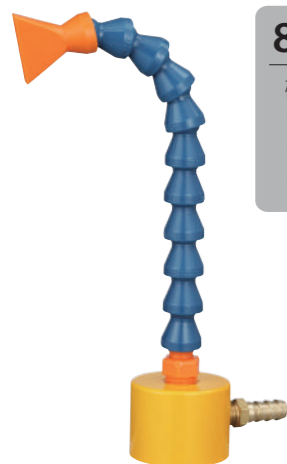

### 88003 磁座組

- 磁座底部 1 組
- 10 顆 1/4" 曲管 1 條
- 1" 扇形噴嘴 1 顆
- 1/4" PT 公牙接頭 1 顆

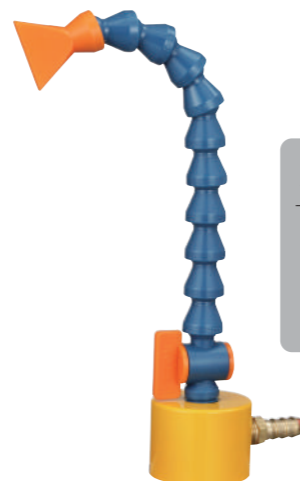

### 88005 磁座組

- 磁座底部 1 組
- 10 顆 1/4" 曲管 1 條
- 1" 扇形噴嘴 1 顆
- 1/4" PT 公牙凡而 1 顆

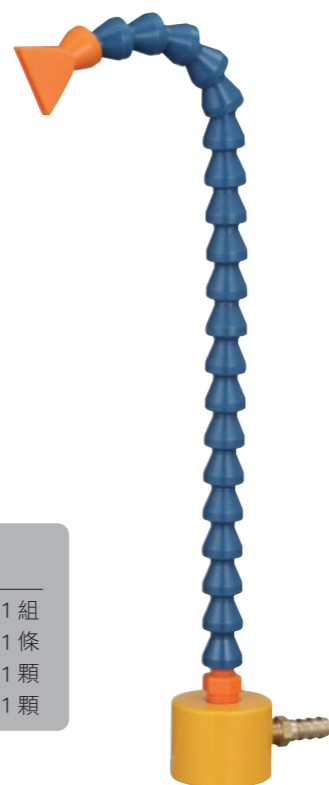

### 88105 磁座組

- 磁座底部 1 組
- 20 顆 1/4" 曲管 1 條
- 1" 扇形噴嘴 1 顆
- 1/4" PT 公牙凡而 1 顆

### 88103 磁座組

- 磁座底部 1 組
- 20 顆 1/4" 曲管 1 條
- 1" 扇形噴嘴 1 顆
- 1/4" PT 公牙接頭 1 顆

## 1/4" 系列規格圖

 14.85 20.1 Ø12.53	 24 Min-Dia 69mm 最大彎曲角度：24°	 15.9 30.3 Ø1.5 Ø3.9	 35.4 27.5 31.1	 29.8 19 Ø2.3 21.8	 33.8 32.1
82021+82021	82022	82023	82024	82025	82026
 26.3 1/8" PT	 21.2 7/16"-20 UNF 牙	 15.9 30.1 Ø3.1 Ø7.55	 27.5 31.1 40.1	 33.8 28.1 24.48 11.9 28.42 17.4 Ø5.1 Ø1.8	 33.8 28.1 Ø15.7
82027	82028	82029	82030	82031	82032
 26.4 1/4" PT 牙	 27 Ø12.53 26.7	 35 Ø6.3 Ø9.93 15.88	 27.5 31.1 44.8	 14.85 22.3 39.78 46.8 Ø1.16	 26.2 5/8"-18 UNF 牙
82033	82034	82035	82036	82037	82038
 29.8 1/4" PT 牙	 19	 24.8 19.8 Ø1.8 Ø4.1	 25.4 19.8 Ø3 Ø5.6	 45.8 46.8 Ø1.16	 45.8 46.8 Ø1.16
82039	82040	82041	82042	82043	82044
 20.8 16.1 1/8" NPT 牙	 25.8 23.1	 41.6 16.6 25.1 Ø21.2	 26.6 20 Ø6.1 Ø9	 41 46.9 Ø1.5-16	 45.8 46.9 Ø1.5-16
82045	82046	82047	82048	82049	82050
 24.9 16.7 1/4" PT 牙	 1.7 29.5 28.6 25	 1.3 30 15.9 7 10	 20.8 9 89.35 184 28°	 65.2 70 Ø1.8*20	 45.1 70 Ø1.8*20
82051	82052	82053	82054	82055	82056
 30.9 28 Ø15.7	 27.9 27.9 Ø15.7 11	 27.9 15.7 11 1.5	 27.8 11.11 Ø17	 27.8 11.16 Ø15.7	 27.8 11.16 Ø15.5
82057	82058	82059	82060	82061	82062



### 3/8" 系列規格圖

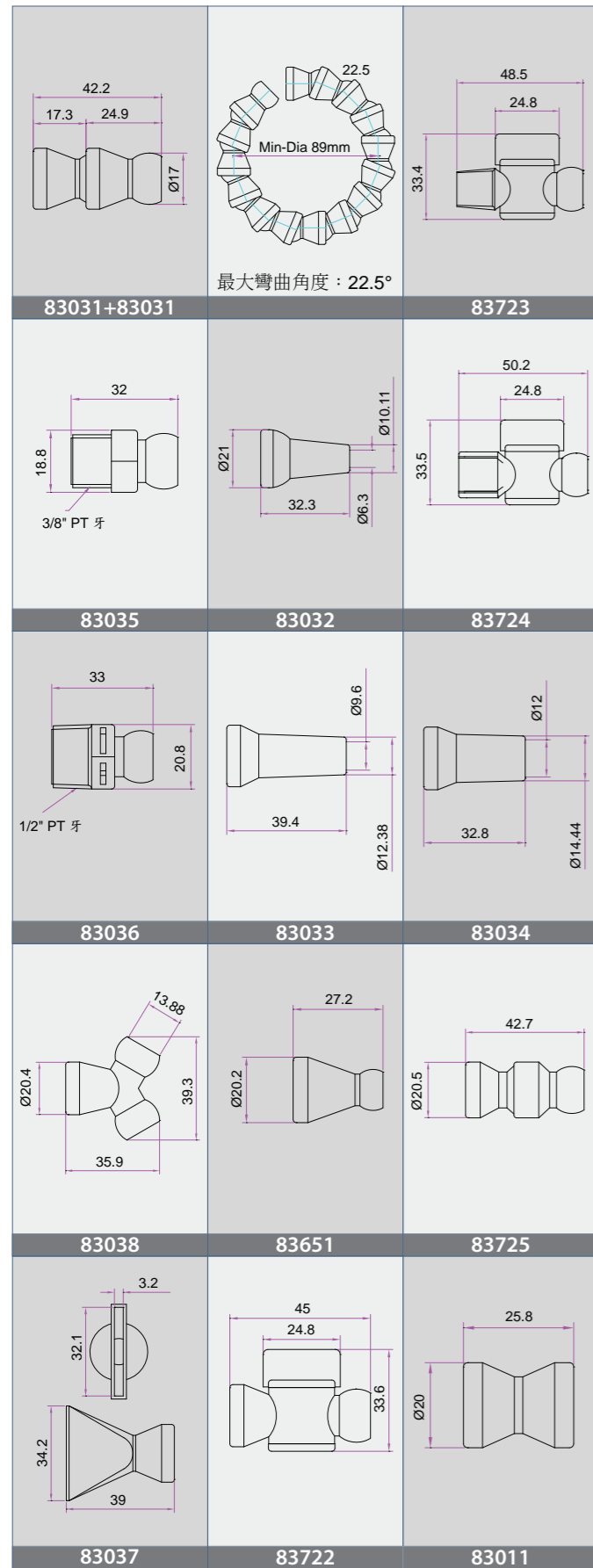

### 1/2" 系列規格圖

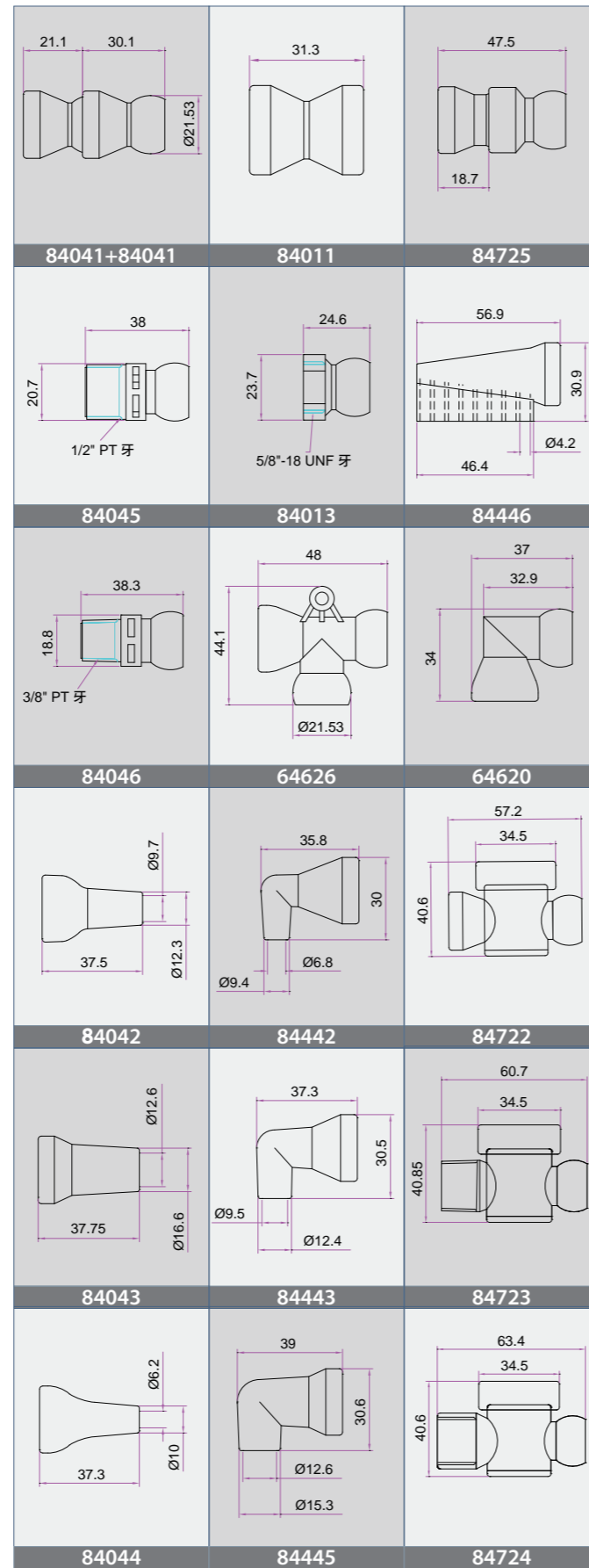

### 1/2" 系列規格圖

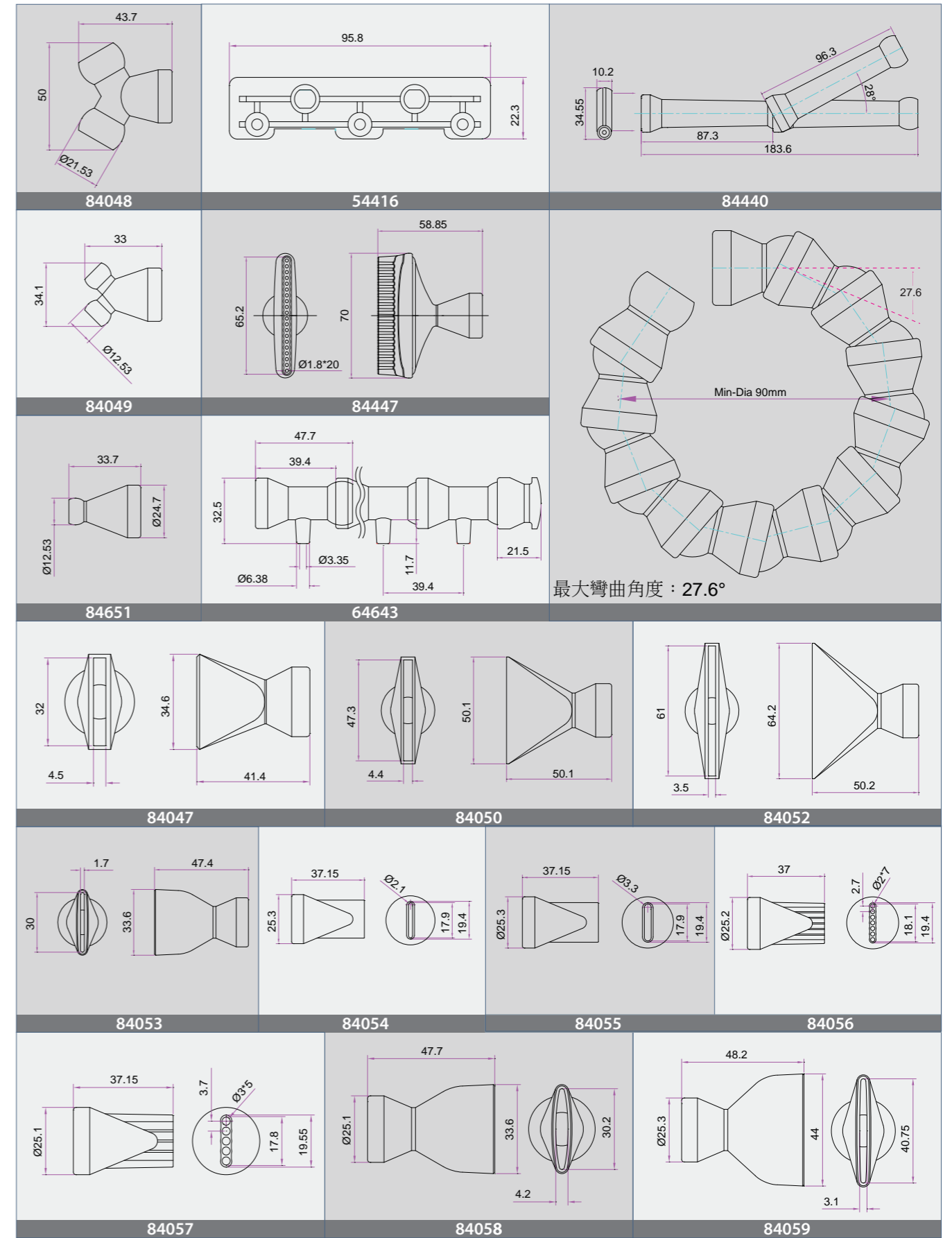

### 3/4"系列規格圖

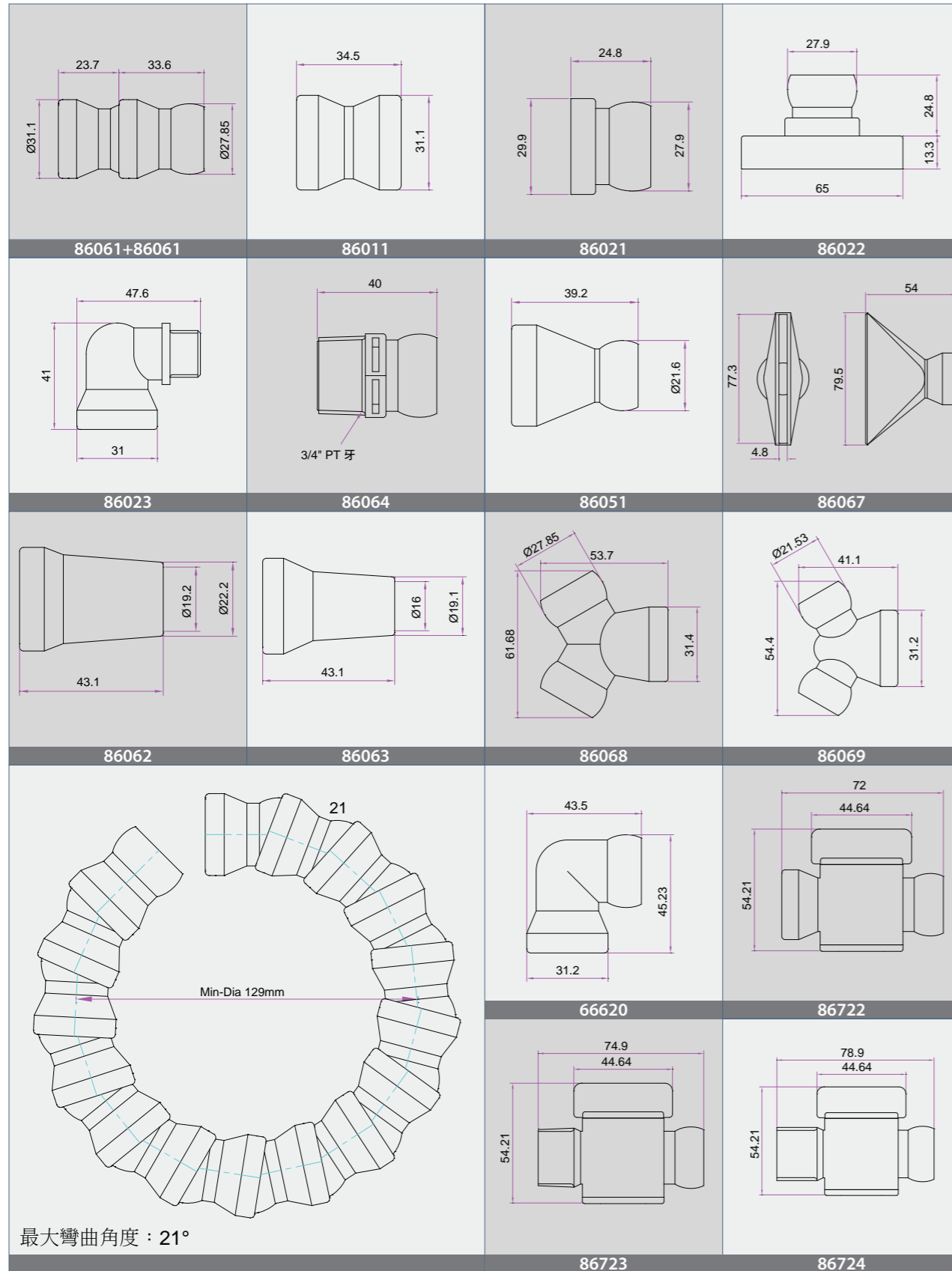

### 2 1/2"系列規格圖

